

## BREAK BAR



### GENERAL INFORMATION:

Bancone counter	
Versions:	standard, lighting
Material:	Polyethylene
Dimensions:	175 x 73 h 110 cm
Weight:	45 Kg
Packaging:	174 x 77 x 111 cm
Packaging volume:	1,487 m <sup>3</sup>
Note:	matching with Ice Bar, Break Corner and Break Line.
Code:	LP BRB110 lighting (IP 55 for indoor and outdoor use) SD BRB110 standard (for indoor and outdoor use)
Wiring with plastic base and LED CANDY LIGHT. IP44 protection. Diameter 10 cm.	
Lamp type:	E 26
Insulation class 2	
Device proper to direct assembly onto normally inflammable surface	

### DIMENSIONS:

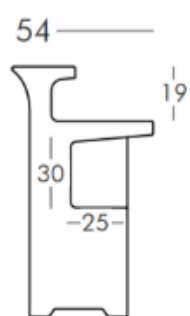
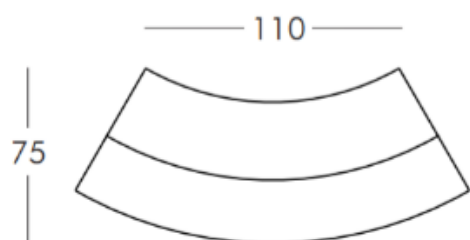
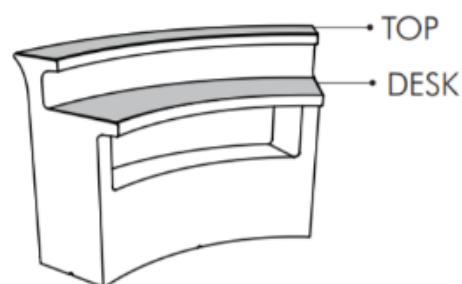
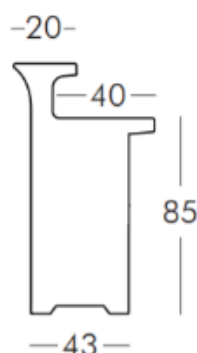
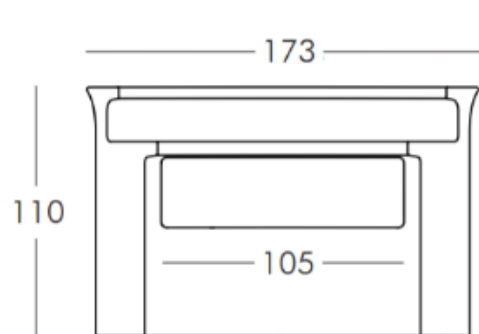

- DESK** (not included) 150 x 55 cm
- LP BRB111 - tempered glass (6 mm / 8,5 Kg)
- LP BRB113 - stainless steel (1 mm / 4,4 Kg)
- TOP** (not included) 170 x 45 cm
- LP BRB112 - tempered glass (6 mm / 8,5 Kg)
- LP BRB114 - stainless steel (1 mm / 2,7 Kg)

### LIGHTING:

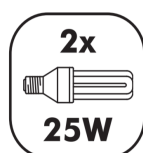
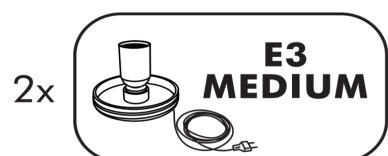

Wiring with plastic screw base. I3 - IP20 protection. E3 - IP55 protection. Diameter 10 cm.

Energy saving bulb recommended (not included).

FINISHES:

## STANDARD

- MILKY WHITE (code FT)
- JET BLACK (code FH)
- ELEPHANT GREY (code FG)
- CHOCOLATE BROWN (code FE)
- ARGIL GREY (code FJ)
- DOVE GREY (code FP)
- POWDER BLUE (code FL)
- MALVA GREEN (code FV)
- LIME GREEN (code FR)
- SAFFRON YELLOW (code FB)
- PUMPKIN ORANGE (code FC)
- FLAME RED (code FD)
- SWEET FUCHSIA (code FU)

## LIGHTING

- LIGHT WHITE (code LA)