



BULLARD BOLLARDS

The FARO family floodlights offers a variety of architectural solutions to both lighting designers and architects. Main distinguish characteristics are pure design, wide range of accessories and high value optic systems. The range of powerful LEDs available meets different goals, both in terms of energy savings and cost reduction for maintenance. Faro is even available for street application in pole version.



Faro St

CERTIFICATION	CE EAC
IP / IK RATING	IP 65 / IK 10
CLASSIFICATION	class I / II ⊕ □
DIMMABLE	dimnable DALI versione available upon request
BODY	extruded aluminium EN AW-6063 T5 / EN-AB 44100
DIFFUSER	soda-lime tempered glass Microfaro 4 mm; Minifaro 4 mm; Faro 6 mm
REFLECTOR	99.99% pure aluminium high vacuum deposit
EXTERNAL FIXINGS	stainless steel A4-70 treated with highly antioxidant water-repellent lubricating solution. The treatment ensures easy opening of the product for maintenance
SEALING GASKET	silicone
CABLE ENTRY	cable gland Microfaro M16; Minifaro M16; Faro M20 13,5 Ø 7/13 mm
POSITIONING	mechanical system allows fixture locking and adjustment on vertical axe. The graduated ring nut allows for accurate positioning.
LIGHT SOURCE	Led integral
FINISH	powder coating polyester high resistance to UV and oxidation

g@gordonbullard.com
www.bullardbollards.com
269-569-6700



991 South Gull Lake Dr
Richland, MI 49083, USA
1 877-964-464



BULLARD BOLLARDS

Faro St

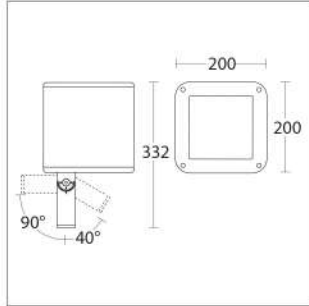

- IP65
- IK06
- RGB upon request
- DALI upon request

colour codes
 .05 anthracite grey
 .13 light grey

1107.ECS.T.-- 32 W Led 3000 K 4920 lm
1107.EDS.T.-- 32 W Led 4000 K 5070 lm
 220-240 V 50/60 HZ
 clear diffuser
 led driver integral

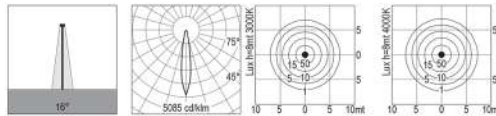

1107.ECM.T.-- 32 W Led 3000 K 4920 lm
1107.EDM.T.-- 32 W Led 4000 K 5070 lm
 220-240 V 50/60 HZ
 clear diffuser
 led driver integral

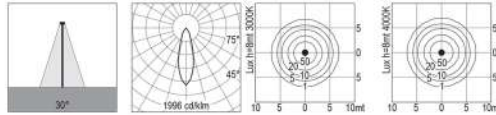

1107.ECF.T.-- 39 W Led 3000 K 5640 lm
1107.CES.T.-- 39 W Led 4000 K 5820 lm
 220-240 V 50/60 HZ
 clear diffuser
 led driver integral

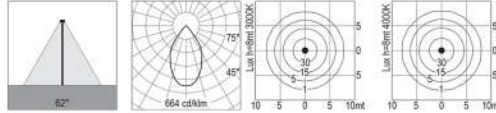

1107.CDS.T.-- 39 W Led 3000 K 5640 lm
1107.CES.T.-- 39 W Led 4000 K 5820 lm
 220-240 V 50/60 HZ
 clear diffuser
 led driver integral

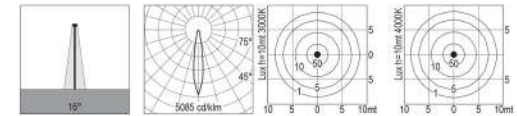

1107.CDM.T.-- 39 W Led 3000 K 5640 lm
1107.CEM.T.-- 39 W Led 4000 K 5820 lm
 220-240 V 50/60 HZ
 clear diffuser
 led driver integral

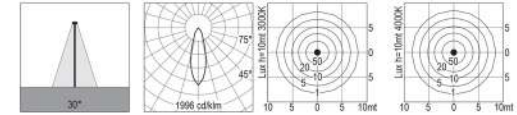

1107.CDF.T.-- 39 W Led 3000 K 5640 lm
1107.CEF.T.-- 39 W Led 4000 K 5820 lm
 220-240 V 50/60 HZ
 clear diffuser
 led driver integral

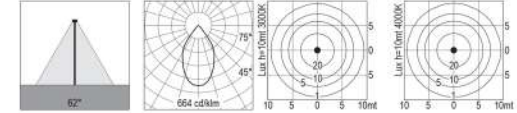



**BULLARD
BOLLARDS**

Faro St

1107.FLS.T.-- 47 W Led 3000 K 6710 lm
1107.FMS.T.-- 47 W Led 4000 K 6920 lm
 220-240 V 50/60 HZ
 clear diffuser
 led driver integral

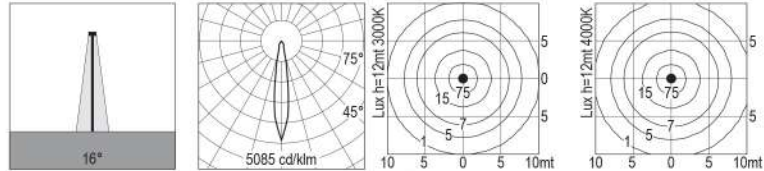

1107.FLM.T.-- 47 W Led 3000 K 6710 lm
1107.FMM.T.-- 47 W Led 4000 K 6920 lm
 220-240 V 50/60 HZ
 clear diffuser
 led driver integral

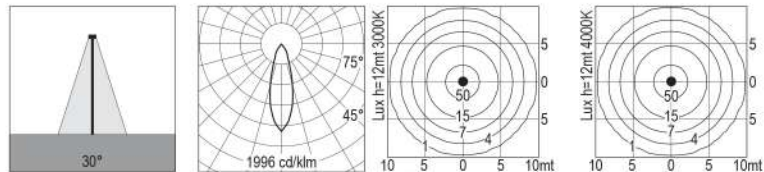

1107.FLF.T.-- 47 W Led 3000 K 6710 lm
1107.FMF.T.-- 47 W Led 4000 K 6920 lm
 220-240 V 50/60 HZ
 clear diffuser
 led driver integral

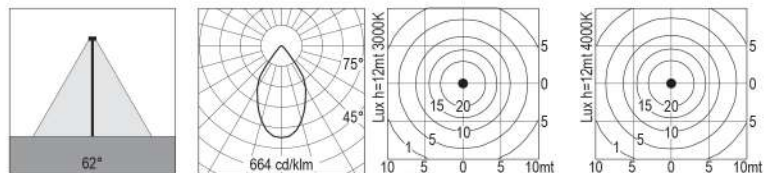

g@gordonbullard.com
www.bullardbollards.com
 269-569-6700



991 South Gull Lake Dr
 Richland, MI 49083, USA
 1 877-964-464



BULLARD
BOLLARDS

Faro St

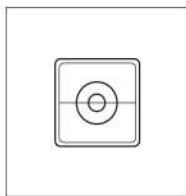

180

Louvre screen anti glare

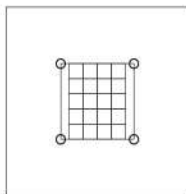

181

Anti vandal screen

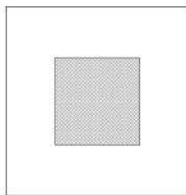

182

Microprismatic lens

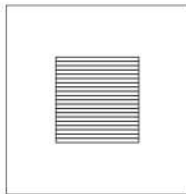

184

Elipsoidal lens

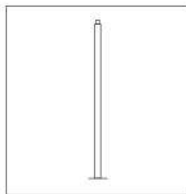

p. 415

Poles

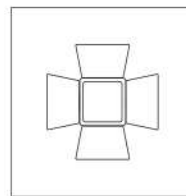

185

Directional flaps

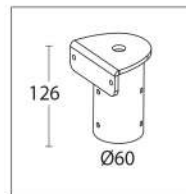

186.--

Head of the column

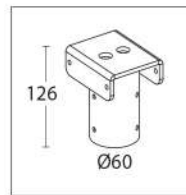

187.--

Double head of the column



coloured films

Upon request