



**BULLARD**  
**BOLLARDS**

**CERTIFICATION**



**IP/IK RATING**

IP 65/ IK 08

**CLASSIFICATION**

Class I



**DIMMABLE**

dimnable DALI versione available upon request

**BODY**

extruded aluminium EN AW-6063 T5 / EN-AB 44100

**DIFFUSER**

soda-lime tempered glass Microfaro 4 mm; Minifaro 4 mm; Faro 6 mm

**REFLECTOR**

pure aluminium high vacuum deposit 99.99%

**EXTERNAL FIXINGS**

.stainless steel A4-70 treated with highly antioxidant water-repellent lubricating solution  
The treatment ensures easy opening of the product for maintenance

**SEALING GASKET**

silicone

**CABLE ENTRY**

cable gland Microfaro M16; Minifaro M16; Faro M20 13,5 Ø 7/13 mm

**POSITIONING**

.mechanical system allows fixture locking and adjustment on vertical axe  
.The graduated ring nut allows for accurate positioning

**LIGHT SOURCE**

Led integral

**FINISH**

powder coating polyester high resistance to UV and oxidation



# Minifaro ST

The FARO family floodlights offers a variety of architectural solutions to both lighting designers and architects. Main distinguish characteristics are pure design, wide range of accessories and high value optic systems. The range of powerful LEDs available meets different goals, both in terms of energy savings and cost reduction for maintenance. Faro is .even available for street application in pole version



[g@gordonbullard.com](mailto:g@gordonbullard.com)  
[www.bullardbollards.com](http://www.bullardbollards.com)  
269-569-6700



991 South Gull Lake Dr  
Richland, MI 49083, USA  
1 877-964-464



# BULLARD BOLLARDS

# Minifaro ST

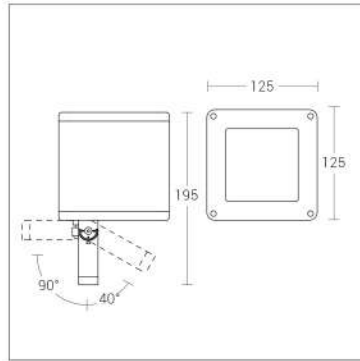

IP65



colour codes  
**05.** anthracite grey  
**13.** light grey

IK08

**DALI**  
upon  
request

**RGB**  
upon  
request

**1133.DGS.T--** 16 W Led 3000 K 2270 lm  
**1133.DHS.T--** 16 W Led 4000 K 2340 lm  
 220-240 V 50/60 HZ   
 clear diffuser  
 led driver integral

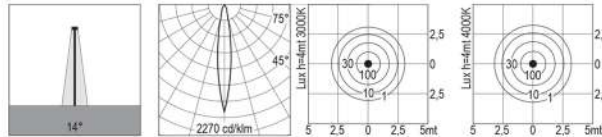

**1133.FNS.T--** 29 W Led 3000 K 3870 lm  
**1133.FPS.T--** 29 W Led 4000 K 3990 lm  
 220-240 V 50/60 HZ   
 clear diffuser  
 led driver integral

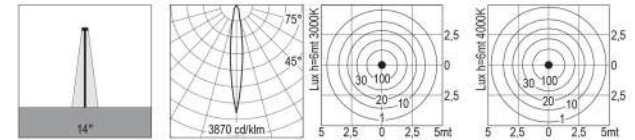

**1133.DGM.T--** 16 W Led 3000 K 2270 lm  
**1133.DHM.T--** 16 W Led 4000 K 2340 lm  
 220-240 V 50/60 HZ   
 clear diffuser  
 led driver integral

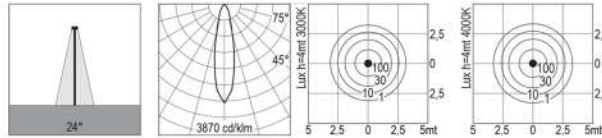

**1133.FNM.T--** 29 W Led 3000 K 3870 lm  
**1133.FPM.T--** 29 W Led 4000 K 3990 lm  
 220-240 V 50/60 HZ   
 clear diffuser  
 led driver integral

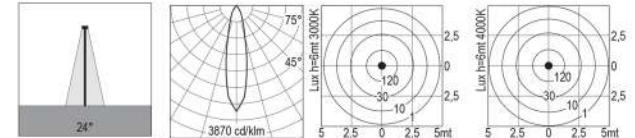

**1133.DGF.T--** 16 W Led 3000 K 2270 lm  
**1133.DHF.T--** 16 W Led 4000 K 2340 lm  
 220-240 V 50/60 HZ   
 clear diffuser  
 led driver integral

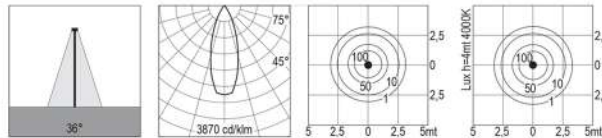

**1133.FNM.T--** 29 W Led 3000 K 3870 lm  
**1133.FPM.T--** 29 W Led 4000 K 3990 lm  
 220-240 V 50/60 HZ   
 clear diffuser  
 led driver integral

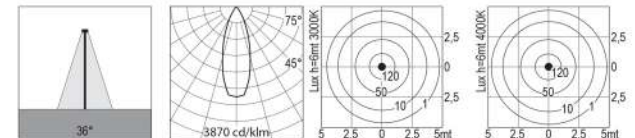

## Accessories

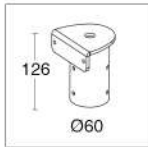

**186--**  
Head of the column

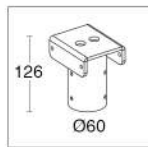

**186--**  
Double head  
of the column

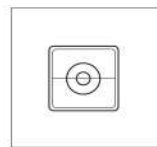

**319**  
Louvre screen anti glare



coloured films  
Upon request

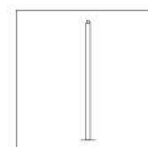

**p. 415**  
Poles

[g@gordonbullard.com](mailto:g@gordonbullard.com)  
[www.bullardbollards.com](http://www.bullardbollards.com)  
 269-569-6700



991 South Gull Lake Dr  
 Richland, MI 49083, USA  
 1 877-964-464

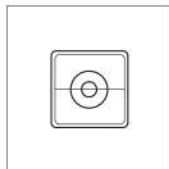

**180**

*Louvre screen anti glare*

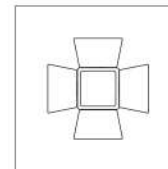

**185**

*Louvre screen anti glare*

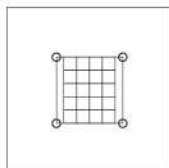

**181**

*Anti vandal screen*

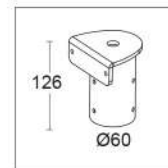

**186.--**

*Anti vandal screen*

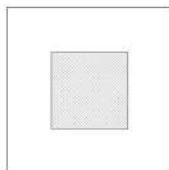

**182**

*Microprismatic lens*

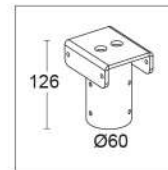

**187.--**

*Double head of the column*

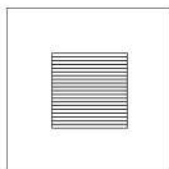

**184**

*Elipsoidal lens*



**coloured films**

*Upon request*

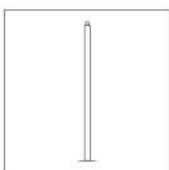

**p. 415**

*Poles*